

ITEM NO.	PART NUMBER	Thickness	Material	QTY.
1	200-UD - Tube	Ø141 x 13 x 360	S355	1
2	200-UD - Cutting Edge	40 x 300	S355	1
3	200-UD - Side Cutter A	30	S355	2
4	200-UD - Side Cutter B	30	S355	2
5	200-UD - Side Plate A	12	S355	2
6	200-UD - Roll Sheet	12	S355	1
7	200-UD - Top Plate Support Plate	12	S355	1
8	200-UD - Wear Bars	10	S355	8
9	200-UD - Side Plate B	8	S355	2
13	6i6354		CAST GET	5
14	1U3352		CAST GET	5

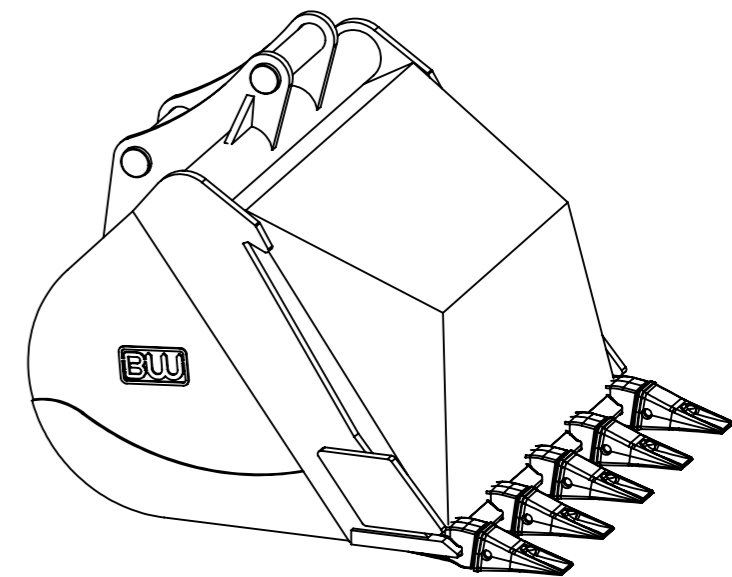

Capacity: 928lt

	S355		HB400		HB500
	EN8		HB450		CAST ALLOY

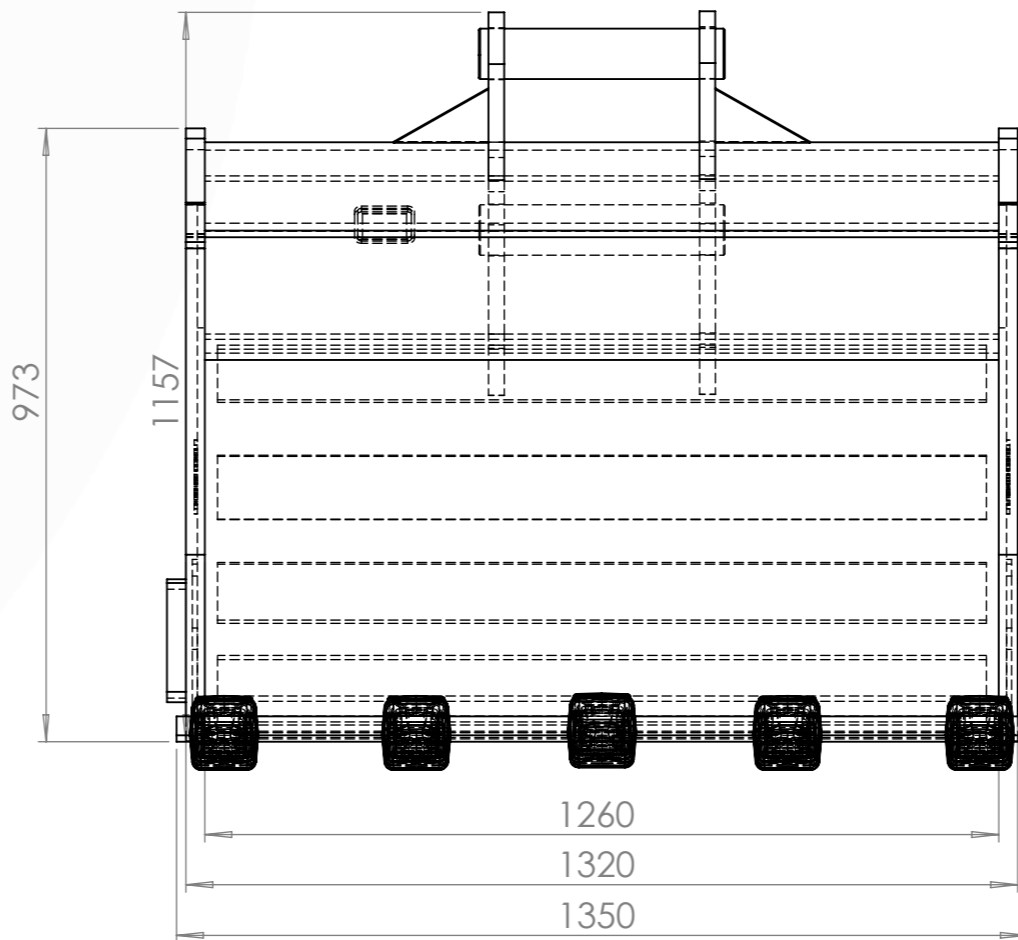
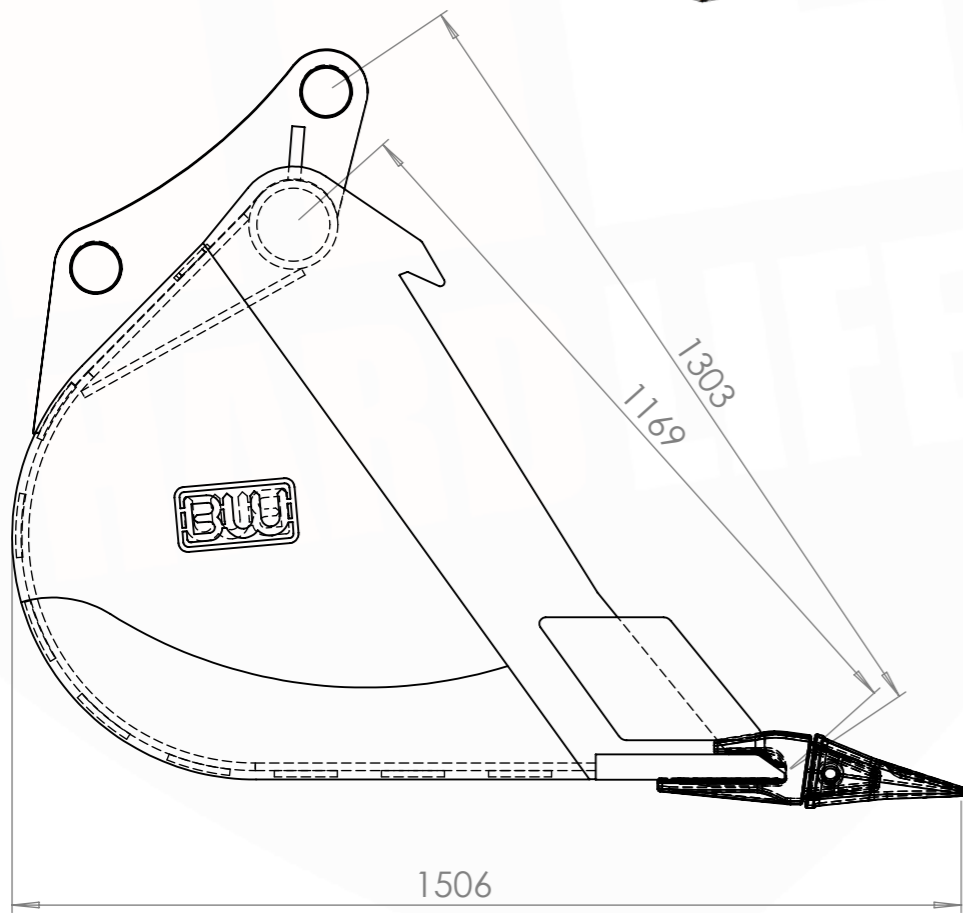

Part No : 200-UD-1350mm - WP80

Machine Class : 17-22 Tonne

Product : UK Dig

Weight : 1800 kg

This drawing is the sole property of Hardlife (UK) Ltd.